

---

TABLE OF CONTENTS

---

Specifications .....	3-2
Quick Spec Guide .....	3-3
Elevations/Sizes: 1/4" Scale	
Single-Hung .....	3-4
Impact Single-Hung .....	3-10
Glazing Options: 3" Scale .....	3-11
Grille Patterns .....	3-12
Section Details: 6" Scale .....	3-13

---

**PRODUCT SPECIFICATIONS**

---

**MATERIALS**

The extruded vinyl profiles comply with the performance requirements of AAMA 303-97. Solid color extrusions are available in White and Desert Sand.

**FRAME**

All frames and sash are assembled using fusion-welding technology for added strength and durability. The frame jamb width is 3" (76.2 mm), and the nominal extrusion exterior wall thickness is 0.070". The frame incorporates an integral nailing fin which can be easily removed to allow the unit to be used in a replacement window application. Weep holes are included on the frame to ensure standing water is directed to the exterior plane of the unit. An interior and exterior accessory groove is standard to accommodate various frame accessory and assembly options on the product. Optional frame types: integral 5/8" flange, snap-in J-channel, snap-in Brickmould, and Box.

**SASH**

The single-hung sash is a 1- 3/8" (35.18mm) nominal thickness, and is assembled using fusion-welding technology for added strength and durability.

**GLAZING**

7/8" (22.2mm) insulated glass consist of two lites of glass sealed around a spacer; 3/4" (19mm) insulated glass for SDL units. The glass is mounted into the sash using a silicone-glazing compound. The insulating glass units comply with the performance requirements of the IGCC in accordance with either ASTM E774 or E2190. All units are exterior glazed.

**GLAZING OPTIONS**

7/8" (22.2mm) or 3/4" (19mm) insulated glass is available in clear, Low-E or Low-E 366, tinted, obscure or other specialty insulating glass as specified. Many glass options are available in tempered glazing, ImpactGard®, or monolithic glass.

**WEATHER-STRIPPING**

A fin-pile weather-strip is applied along the perimeter of the operating sash and at main sill.

**HARDWARE**

A single action cam style lock is available on all windows. Spiral balance systems are utilized to support the vertical operation of the sash. Low profile pivot pins are equipped for utilization of the "tilt" function.

**INSECT SCREENS**

The exterior fiberglass charcoal color insect screen is set in an aluminum frame to match the color of the unit. The spring loaded screen system assists in keeping it secured to the window. Insect screens are intended to allow air and light in and keep insects out. They are not intended to keep anyone or anything from falling through an open door or window. For safety screens or other security devices contact your local building supply retailer.

**GRILLES**

**SDL** (Simulated Divided Lite) 1" (25.4mm) color-matched extruded aluminum contour muntins surface mounted on the exterior surfaces of the insulated glass unit to provide a true divided lite appearance.

**GBG** (Grilles between the Glass) - 5/8" (16mm) and 7/8" (22.2mm) flat or 5/8" (16mm) contour grilles mounted between the glass panes suspended within the air cavity and color matched to the extrusion color.

**EXTENSION JAMBS**

Extension jambs are regionally available for JELD-WEN vinyl products. The 4-9/16" and 6-9/16" extension jambs are available in primed finger-joint and clear pine.

**ADDITIONAL ACCESSORIES**

Additional accessories are available for JELD-WEN Vinyl products. Please contact your local building supply retailer for a complete listing of the additional accessories. See [www.jeld-wen.com/findsupplier](http://www.jeld-wen.com/findsupplier).

**INSTALLATION**

See [www.jeld-wen.com/resources](http://www.jeld-wen.com/resources) for instructions.

**PERFORMANCE**

**NFRC Certified** - (rated and labeled in accordance with NFRC)











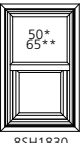



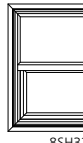

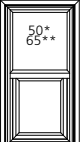

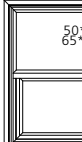

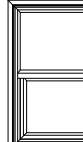
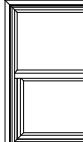

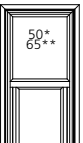





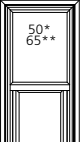

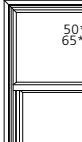



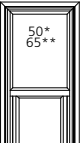

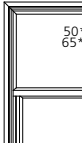



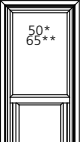

**AAMA/NWDMA I.S.2-97**

Please reference [www.jeld-wen.com/performance](http://www.jeld-wen.com/performance) ratings for up to date Design Pressure and approval information.

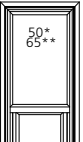
QUICK SPEC GUIDE

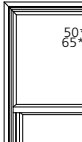
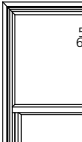
SPECIFICATION	STANDARD FEATURES	OPTIONAL FEATURES
<b>COLOR</b>	<ul style="list-style-type: none"> <li>White</li> </ul>	<ul style="list-style-type: none"> <li>Desert Sand</li> </ul>
<b>SIZE</b>	<ul style="list-style-type: none"> <li>Width: 17-1/2" - 53-1/2"</li> <li>Height: 24-1/2" - 74"</li> </ul>	
<b>FRAME</b>	<ul style="list-style-type: none"> <li>Nail Fin</li> </ul>	<ul style="list-style-type: none"> <li>J-Channel</li> <li>Box Frame</li> <li>Brickmould</li> <li>5/8" Flange</li> <li>2-3/8" Flange Extender</li> </ul>
<b>GLAZING</b>	<ul style="list-style-type: none"> <li>7/8" Insulated Clear</li> </ul>	<ul style="list-style-type: none"> <li>Tempered</li> <li>Low-E</li> <li>Bronze</li> <li>Gray</li> <li>Green</li> <li>Obscure</li> <li>Azurlite</li> <li>Graylite (Turtle)</li> <li>Bronze Reflective</li> </ul>
<b>IMPACTGARD PROTECTION</b>		<ul style="list-style-type: none"> <li>PVB Impact</li> <li>PVB Impact Insulated</li> <li>SGP Impact Single-Glaze</li> <li>SGP Impact Standard Insulated</li> <li>SGP Impact ImpactGard Insulated</li> </ul> <p style="text-align: center;"><i>Not available in tempered. PVB monolithic not available in Low-E. All other tint and obscure glazing options apply.</i></p>
<b>HARDWARE</b>	<ul style="list-style-type: none"> <li>Locking Cam-Lock</li> </ul>	
<b>HARDWARE COLOR</b>	<ul style="list-style-type: none"> <li>Matches Frame</li> </ul>	
<b>SCREENS</b>	<ul style="list-style-type: none"> <li>Fiberglass</li> </ul>	
<b>SCREEN FRAME COLOR</b>	<ul style="list-style-type: none"> <li>Matches Frame</li> </ul>	
<b>GRILLES</b>		<ul style="list-style-type: none"> <li>SDL - 1" Simulated Divided Lite</li> <li>5/8", 7/8" Flat GBG*</li> <li>5/8" Contour</li> </ul> <p style="text-align: center;"><i>*Check for availability</i></p>
<b>JAMB</b>	<ul style="list-style-type: none"> <li>3"</li> </ul>	

## SINGLE-HUNG UNITS

UNIT SIZE	19 3/4" (502)	25 3/4" (654)	27 3/4" (705)	31 3/4" (806)	33 3/4" (857)	35 3/4" (908)	37 3/4" (959)
ROUGH OPENING	18" (457)	24" (610)	26" (660)	30" (762)	32" (813)	34" (864)	36" (914)
FRAME SIZE	17 1/2" (445)	23 1/2" (597)	25 1/2" (648)	29 1/2" (749)	31 1/2" (800)	33 1/2" (851)	35 1/2" (902)
DAYLIGHT OPENING	13 9/16" (344)	19 9/16" (497)	21 9/16" (547)	25 9/16" (649)	27 9/16" (700)	29 9/16" (751)	31 9/16" (802)
31 3/4" (806) 30" (762) 29 1/2" (749) 10" (254) 11 13/32" (290)	 85H1830	 85H2430	 85H2630	 85H3030	 85H3230	 85H3430	 85H3630
37 3/4" (959) 36" (914) 35 1/2" (902) 13" (330) 14 13/32" (366)	 85H1836	 85H2436	 85H2636	 85H3036	 85H3236	 85H3436	 85H3636
39 3/4" (1010) 38" (965) 37 1/2" (953) 14" (356) 15 13/32" (391)	 85H1838	 85H2438	 85H2638	 85H3038	 85H3238	 85H3438	 85H3638
43 3/4" (1111) 42" (1067) 41 1/2" (1054) 16" (406) 17 13/32" (442)	 85H1842	 85H2442	 85H2642	 85H3042	 85H3242	 85H3442	 85H3642
45 3/4" (1162) 44" (1118) 43 1/2" (1105) 17" (432) 18 13/32" (468)	 85H1844	 85H2444	 85H2644	 85H3044	 85H3244	 85H3444	 85H3644
49 3/4" (1264) 48" (1219) 47 1/2" (1207) 19" (483) 20 13/32" (519)	 85H1848	 85H2448	 85H2648	 85H3048	 85H3248	 85H3448	 85H3648
53 3/4" (1365) 52" (1321) 51 1/2" (1308) 21" (533) 22 13/32" (569)	 85H1852	 85H2452	 85H2652	 85H3052	 85H3252	 85H3452	 85H3652

**ELEVATION SYMBOL LEGEND:**  
 VALUES IN () ARE IN MILLIMETER CONVERSIONS.  
 ##\* NUMBER INDICATES DESIGN PRESSURE (DP) RATING WITH STANDARD GLAZING.  
 ##\*\* NUMBER INDICATES OPTIONAL DESIGN PRESSURE (DP) RATING.

SCALE: 1/4" = 1'

### SINGLE-HUNG UNITS

**UNIT SIZE**  
**ROUGH OPENING**  
**FRAME SIZE**  
**DAYLIGHT OPENING**

19 3/4" (502)  
18" (457)  
17 1/2" (445)  
13 9/16" (344)

55 3/4" (1416)  
54" (1372)  
53 1/2" (1359)  
22" (559)  
23 13/32" (595)

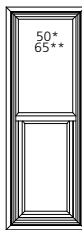

85H1854

25 3/4" (654)  
24" (610)  
23 1/2" (597)  
19 9/16" (497)

50\*  
65\*\*

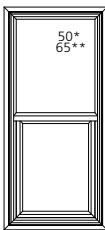

85H2454

27 3/4" (705)  
26" (660)  
25 1/2" (648)  
21 9/16" (547)

50\*  
65\*\*

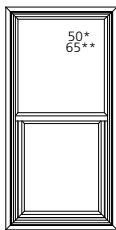

85H2654

31 3/4" (806)  
30" (762)  
29 1/2" (749)  
25 9/16" (649)

50\*  
65\*\*

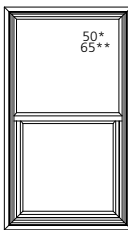

85H3054

33 3/4" (857)  
32" (813)  
31 1/2" (800)  
27 9/16" (700)

50\*  
65\*\*

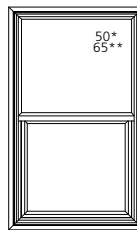

85H3254

35 3/4" (908)  
34" (864)  
33 1/2" (851)  
29 9/16" (751)

50\*  
65\*\*

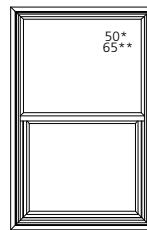

85H3454

37 3/4" (959)  
36" (914)  
35 1/2" (902)  
31 9/16" (802)

50\*  
65\*\*

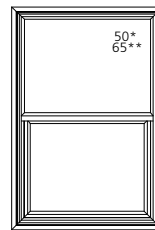

85H3654

61 3/4" (1568)  
60" (1524)  
59 1/2" (1511)  
25" (635)  
26 13/32" (671)

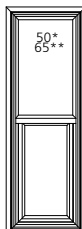

85H1860

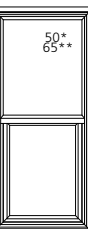

85H2460

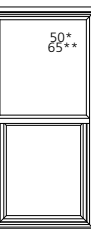

85H2660



85H3060



85H3260



85H3460



85H3660

63 3/4" (1619)  
62" (1575)  
61 1/2" (1562)  
26" (660)  
27 13/32" (696)

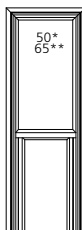

85H1862

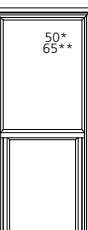

85H2462

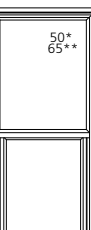

85H2662



85H3062



85H3262



85H3462



85H3662

67 3/4" (1721)  
66" (1676)  
65 1/2" (1664)  
28" (711)  
29 13/32" (747)

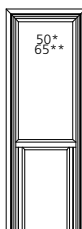

85H1866

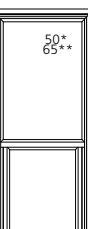

85H2466

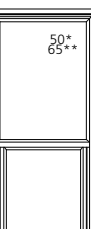

85H2666



85H3066



85H3266



85H3466



85H3666

73 3/4" (1873)  
72" (1829)  
71 1/2" (1816)  
31" (787)  
32 13/32" (823)

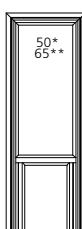

85H1872

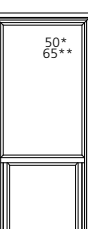

85H2472



85H2672



85H3072



85H3272



85H3472



85H3672

**ELEVATION SYMBOL LEGEND:**

VALUES IN ( ) ARE IN MILLIMETER CONVERSIONS.

\*\*\* NUMBER INDICATES DESIGN PRESSURE (DP) RATING WITH STANDARD GLAZING.

\*\*\*\* NUMBER INDICATES OPTIONAL DESIGN PRESSURE (DP) RATING.

E UNIT MEETS EGRESS REQUIREMENTS FOR IRC CODE. STATE AND LOCAL EGRESS CODES MAY DIFFER. ALWAYS REFER TO LOCAL BUILDING CODES FOR COMPLETE REQUIREMENTS. CHECK WITH LOCAL OFFICIALS TO ENSURE COMPLIANCE BEFORE INSTALLING THE UNIT.

SCALE: 1/4" = 1'

**SINGLE-HUNG UNITS**

**UNIT SIZE** 19 3/4" (502)  
**ROUGH OPENING** 18" (457)  
**FRAME SIZE** 17 1/2" (445)  
**DAYLIGHT OPENING** 13 9/16" (344)

25 3/4" (654)  
 24" (610)  
 23 1/2" (597)  
 19 9/16" (497)

27 3/4" (705)  
 26" (660)  
 25 1/2" (648)  
 21 9/16" (547)

31 3/4" (806)  
 30" (762)  
 29 1/2" (749)  
 25 9/16" (649)

33 3/4" (857)  
 32" (813)  
 31 1/2" (800)  
 27 9/16" (700)

35 3/4" (908)  
 34" (864)  
 33 1/2" (851)  
 29 9/16" (751)

37 3/4" (959)  
 36" (914)  
 35 1/2" (902)  
 31 9/16" (802)

75 3/4" (1924)  
 74" (1880)  
 73 1/2" (1867)  
 32" (813)  
 33 13/32" (849)

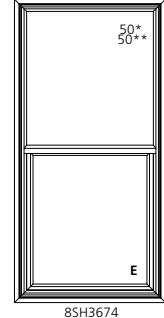
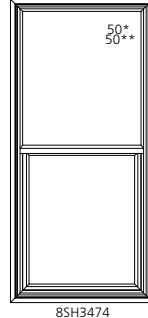
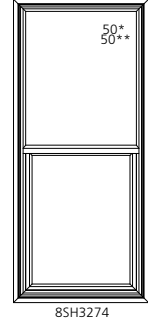
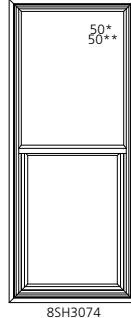
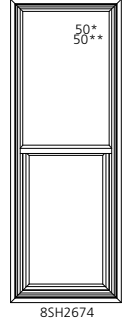
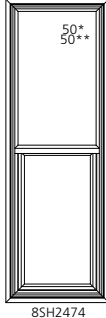
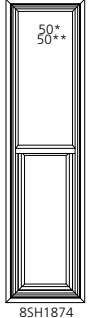











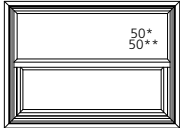
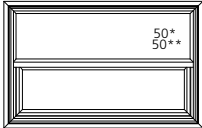

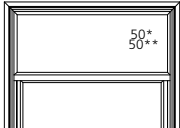
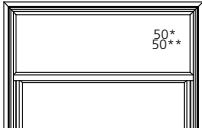
**ELEVATION SYMBOL LEGEND:**

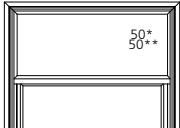
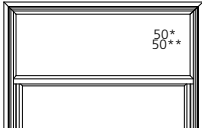
VALUES IN ( ) ARE IN MILLIMETER CONVERSIONS.  
**##\*** NUMBER INDICATES DESIGN PRESSURE (DP) RATING WITH STANDARD GLAZING.  
**###\*** NUMBER INDICATES OPTIONAL DESIGN PRESSURE (DP) RATING.  
**E** UNIT MEETS EGRESS REQUIREMENTS FOR IRC CODE. STATE AND LOCAL EGRESS CODES MAY DIFFER. ALWAYS REFER TO LOCAL BUILDING CODES FOR COMPLETE REQUIREMENTS. CHECK WITH LOCAL OFFICIALS TO ENSURE COMPLIANCE BEFORE INSTALLING THE UNIT.

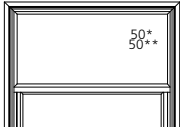
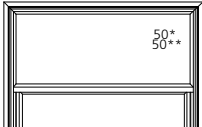
SCALE: 1/4" = 1'

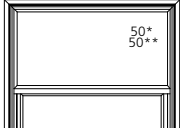
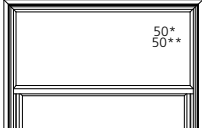
### SINGLE-HUNG UNITS

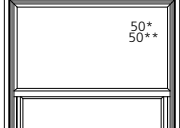
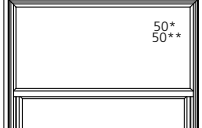
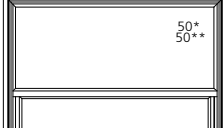
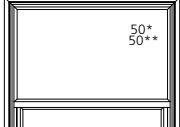
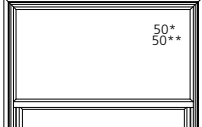
**UNIT SIZE**  
**ROUGH OPENING**  
**FRAME SIZE**  
**DAYLIGHT OPENING**

UNIT SIZE ROUGH OPENING FRAME SIZE DAYLIGHT OPENING	43 3/4" (1111) 42" (1067) 41 1/2" (1054) 37 9/16" (954)	49 3/4" (1264) 48" (1219) 47 1/2" (1207) 43 9/16" (1106)	55 3/4" (1416) 54" (1372) 53 1/2" (1359) 49 9/16" (1259)
31 3/4" (806) 30" (762) 29 1/2" (749) 10" (254) 11 13/32" (290)	 85H4230	 85H4830	 85H5430
37 3/4" (959) 36" (914) 35 1/2" (902) 13" (330) 14 13/32" (366)	 85H4236	 85H4836	 85H5436
39 3/4" (1010) 38" (965) 37 1/2" (953) 14" (356) 15 13/32" (391)	 85H4238	 85H4838	 85H5438
43 3/4" (1111) 42" (1067) 41 1/2" (1054) 16" (406) 17 13/32" (442)	 85H4242	 85H4842	 85H5442
45 3/4" (1162) 44" (1118) 43 1/2" (1105) 17" (432) 18 13/32" (468)	 85H4244	 85H4844	 85H5444
49 3/4" (1264) 48" (1219) 47 1/2" (1207) 19" (483) 20 13/32" (519)	 85H4248	 85H4848	 85H5448
53 3/4" (1365) 52" (1321) 51 1/2" (1308) 21" (533) 22 13/32" (569)	 85H4252	 85H4852	 85H5452

**ELEVATION SYMBOL LEGEND:**  
VALUES IN ( ) ARE IN MILLIMETER CONVERSIONS.  
\*\*\* NUMBER INDICATES DESIGN PRESSURE (DP) RATING WITH STANDARD GLAZING.  
\*\*\*\* NUMBER INDICATES OPTIONAL DESIGN PRESSURE (DP) RATING.

SCALE: 1/4" = 1'

### SINGLE-HUNG UNITS

**UNIT SIZE**  
**ROUGH OPENING**  
**FRAME SIZE**  
**DAYLIGHT OPENING**

43 3/4" (1111)  
42" (1067)  
41 1/2" (1054)  
37 9/16" (954)

49 3/4" (1264)  
48" (1219)  
47 1/2" (1207)  
43 9/16" (1106)

55 3/4" (1416)  
54" (1372)  
53 1/2" (1359)  
49 9/16" (1259)

55 3/4" (1416)  
54" (1372)  
53 1/2" (1359)  
22" (559)  
23 13/32" (595)

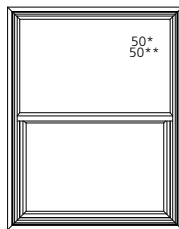

85H4254

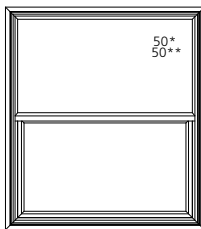

85H4854

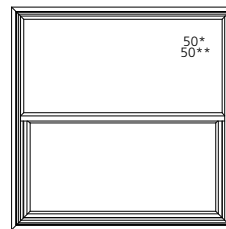

85H5454

61 3/4" (1568)  
60" (1524)  
59 1/2" (1511)  
25" (635)  
26 13/32" (671)

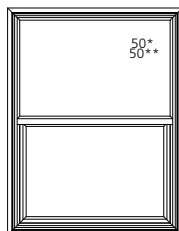

85H4260

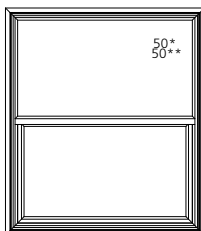

85H4860

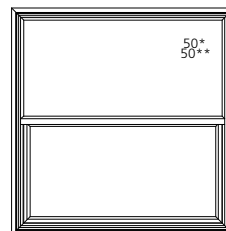

85H5460

63 3/4" (1619)  
62" (1575)  
61 1/2" (1562)  
26" (660)  
27 13/32" (696)

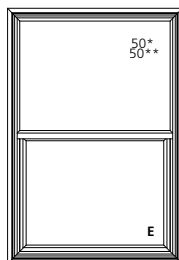

85H4262

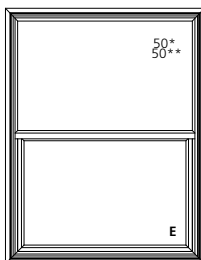

85H4862

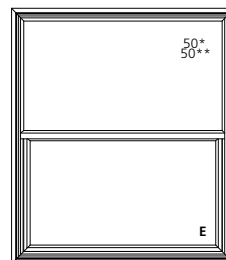

85H5462

67 3/4" (1721)  
66" (1676)  
65 1/2" (1664)  
28" (711)  
29 13/32" (747)

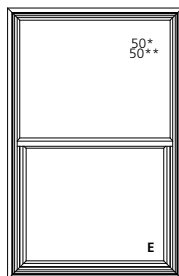

85H4266

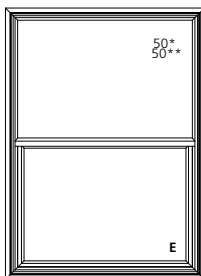

85H4866

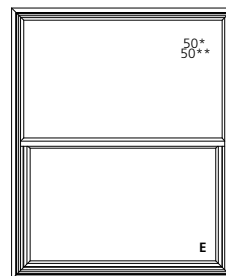

85H5466

73 3/4" (1873)  
72" (1829)  
71 1/2" (1816)  
31" (787)  
32 13/32" (823)

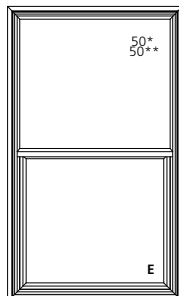

85H4272

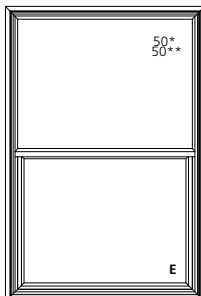

85H4872

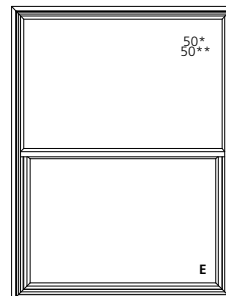

85H5472

**ELEVATION SYMBOL LEGEND:**

VALUES IN () ARE IN MILLIMETER CONVERSIONS.

### NUMBER INDICATES DESIGN PRESSURE (DP) RATING WITH STANDARD GLAZING.

###\* NUMBER INDICATES OPTIONAL DESIGN PRESSURE (DP) RATING.

E UNIT MEETS EGRESS REQUIREMENTS FOR IRC CODE. STATE AND LOCAL EGRESS CODES MAY DIFFER. ALWAYS REFER TO LOCAL BUILDING CODES FOR COMPLETE REQUIREMENTS. CHECK WITH LOCAL OFFICIALS TO ENSURE COMPLIANCE BEFORE INSTALLING THE UNIT.

SCALE: 1/4" = 1'



**SINGLE-HUNG UNITS**

	43 3/4" (1111)	49 3/4" (1264)	55 3/4" (1416)
<b>UNIT SIZE</b>	42" (1067)	48" (1219)	54" (1372)
<b>ROUGH OPENING</b>	41 1/2" (1054)	47 1/2" (1207)	53 1/2" (1359)
<b>FRAME SIZE</b>	37 9/16" (954)	43 9/16" (1106)	49 9/16" (1259)
<b>DAYLIGHT OPENING</b>			

<p>75 3/4" (1924) 74" (1880) 73 1/2" (1867) 32" (813) 33 13/32" (849)</p>			
---	--	--	--

**ELEVATION SYMBOL LEGEND:**  
VALUES IN ( ) ARE IN MILLIMETER CONVERSIONS.  
**##\*** NUMBER INDICATES DESIGN PRESSURE (DP) RATING WITH STANDARD GLAZING.  
**###\*** NUMBER INDICATES OPTIONAL DESIGN PRESSURE (DP) RATING.  
**E** UNIT MEETS EGRESS REQUIREMENTS FOR IRC CODE. STATE AND LOCAL EGRESS CODES MAY DIFFER. ALWAYS REFER TO LOCAL BUILDING CODES FOR COMPLETE REQUIREMENTS. CHECK WITH LOCAL OFFICIALS TO ENSURE COMPLIANCE BEFORE INSTALLING THE UNIT.

SCALE: 1/4" = 1'

### SINGLE-HUNG UNITS - FLORIDA SIZES

#### IMPACT

UNIT SIZE	20 1/8" (511)	27 1/2" (699)	38" (965)	54 1/8" (1375)
ROUGH OPENING	18 3/8" (467)	25 3/4" (654)	36 1/4" (921)	52 3/8" (1330)
FRAME SIZE	17 7/8" (454)	25 1/4" (641)	35 3/4" (908)	51 7/8" (1318)
DAYLIGHT OPENING	13 15/16" (354)	21 5/16" (541)	31 13/16" (808)	47 15/16" (1217)
27" (686) 25 1/4" (641) 24 3/4" (629) 7 9/16" (192) 9 1/8" (232)				
39 3/8" (1000) 37 5/8" (956) 37 1/8" (943) 13 3/4" (349) 15 5/16" (389)				
51 5/8" (1311) 49 7/8" (1267) 49 3/8" (1254) 19 7/8" (505) 21 7/16" (545)				
64" (1626) 62 1/4" (1581) 61 3/4" (1568) 25 9/16" (649) 27 7/8" (689)				
73" (1854) 71 1/4" (1810) 70 3/4" (1797) 29 9/16" (751) 31 7/8" (791)				

**ELEVATION SYMBOL LEGEND:**

VALUES IN ( ) ARE IN MILLIMETER CONVERSIONS.

##\* NUMBER INDICATES DESIGN PRESSURE (DP) RATING WITH STANDARD GLAZING.

##\*\* NUMBER INDICATES OPTIONAL DESIGN PRESSURE (DP) RATING.

E UNIT MEETS EGRESS REQUIREMENTS FOR IRC CODE. STATE AND LOCAL EGRESS CODES MAY DIFFER. ALWAYS REFER TO LOCAL BUILDING CODES FOR COMPLETE REQUIREMENTS. CHECK WITH LOCAL OFFICIALS TO ENSURE COMPLIANCE BEFORE INSTALLING THE UNIT.

SCALE: 1/4" = 1'

**GLAZING OPTIONS**

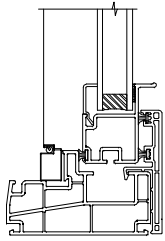

**3/4" IG  
1/8" GLASS SIZE**

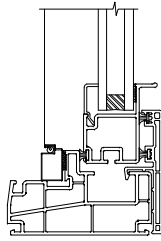

**3/4" IG  
3/16" GLASS SIZE**

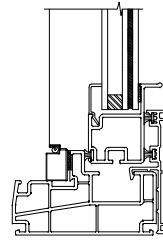

**3/4" LAMINATED GLASS  
1/8" GLASS SIZE**

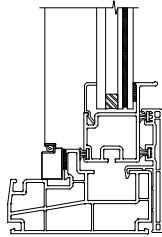

**3/4" LAMINATED GLASS  
3/16" GLASS SIZE**

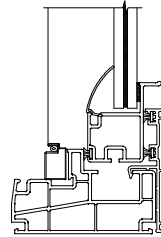

**MONO GLAZED IMPACT GLASS  
7/16" GLASS SIZE**

---

**GRILLES PATTERNS**

---

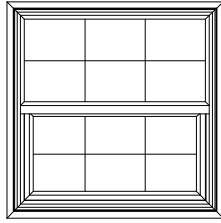

STANDARD

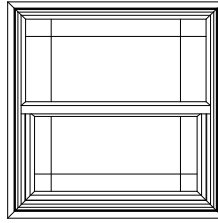

PRAIRIE

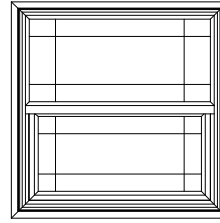

PRAIRIE SASH

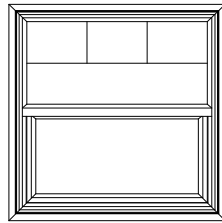

COLONIAL TOP SASH  
1/2 LITE

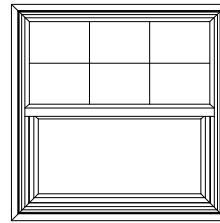

COLONIAL TOP SASH

**SINGLE-HUNG UNIT  
NAIL FIN**

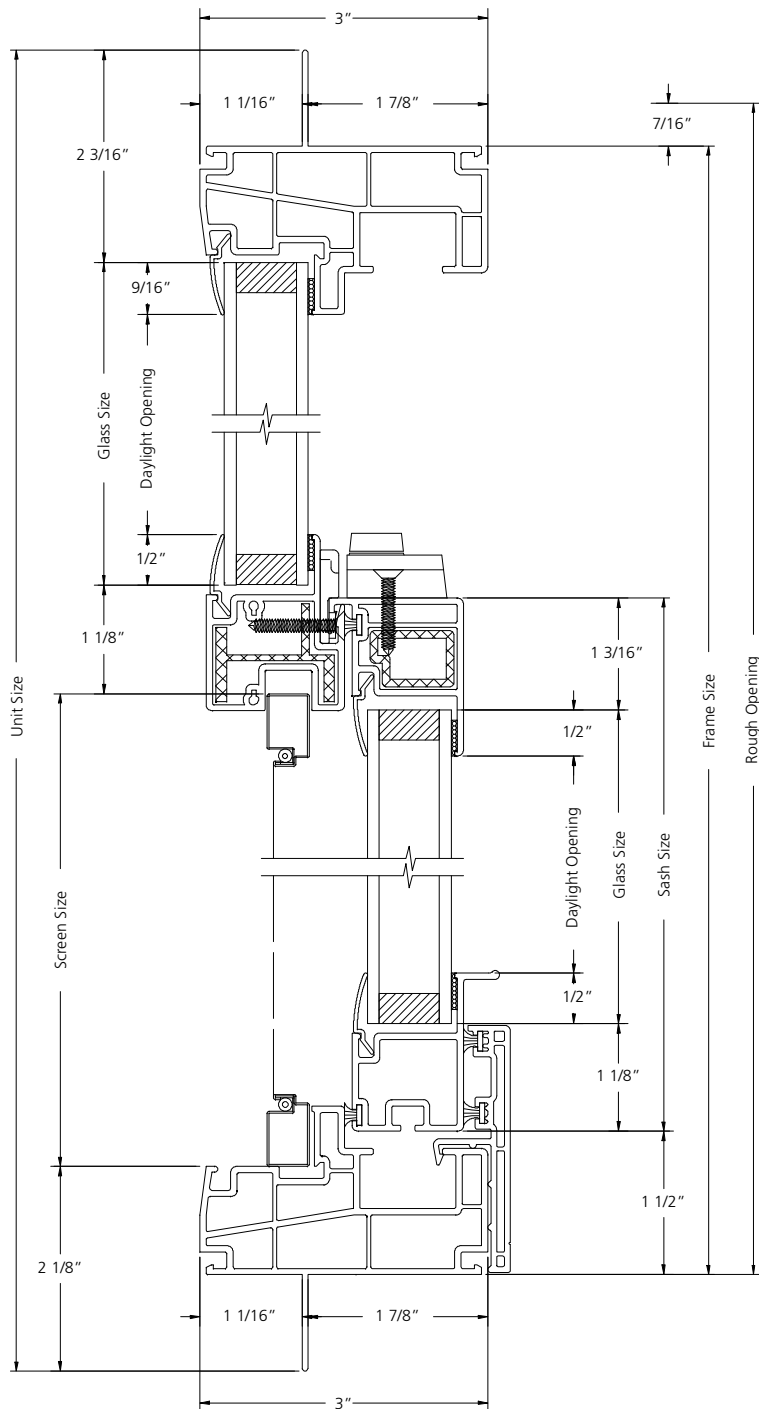

**VERTICAL SECTION**

SCALE: 6" = 1'

**SINGLE-HUNG UNIT  
NAIL FIN**

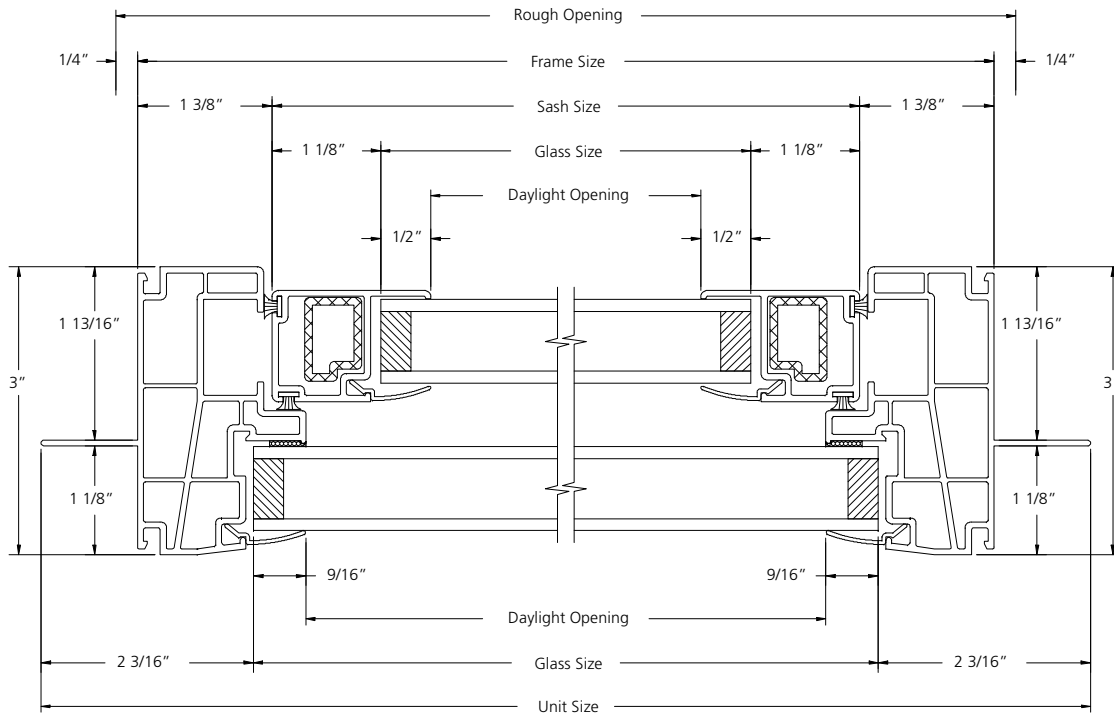

**HORIZONTAL SECTION**

SCALE: 6" = 1'

**SINGLE-HUNG UNIT  
FLANGE**

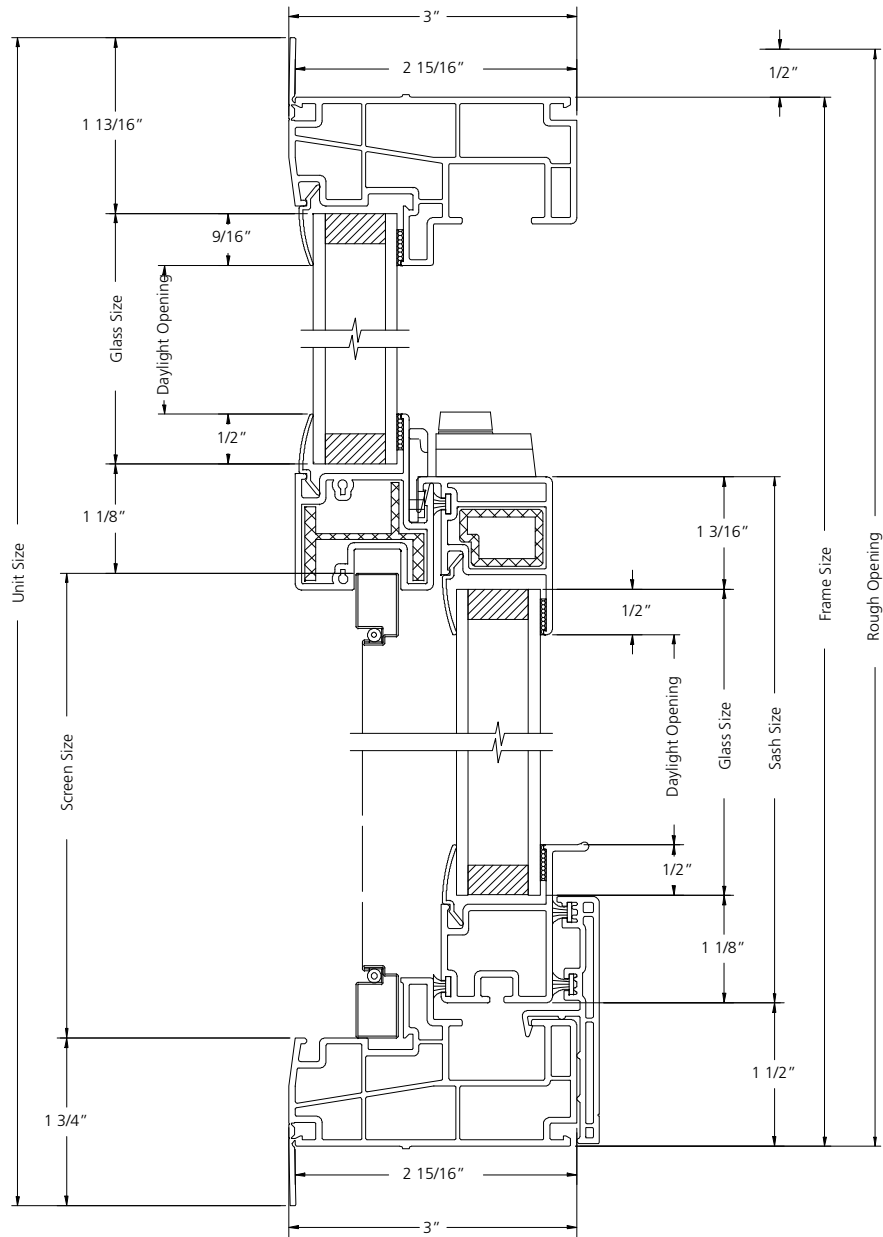

**VERTICAL SECTION**

SCALE: 6" = 1'

**SINGLE-HUNG UNIT  
FLANGE**

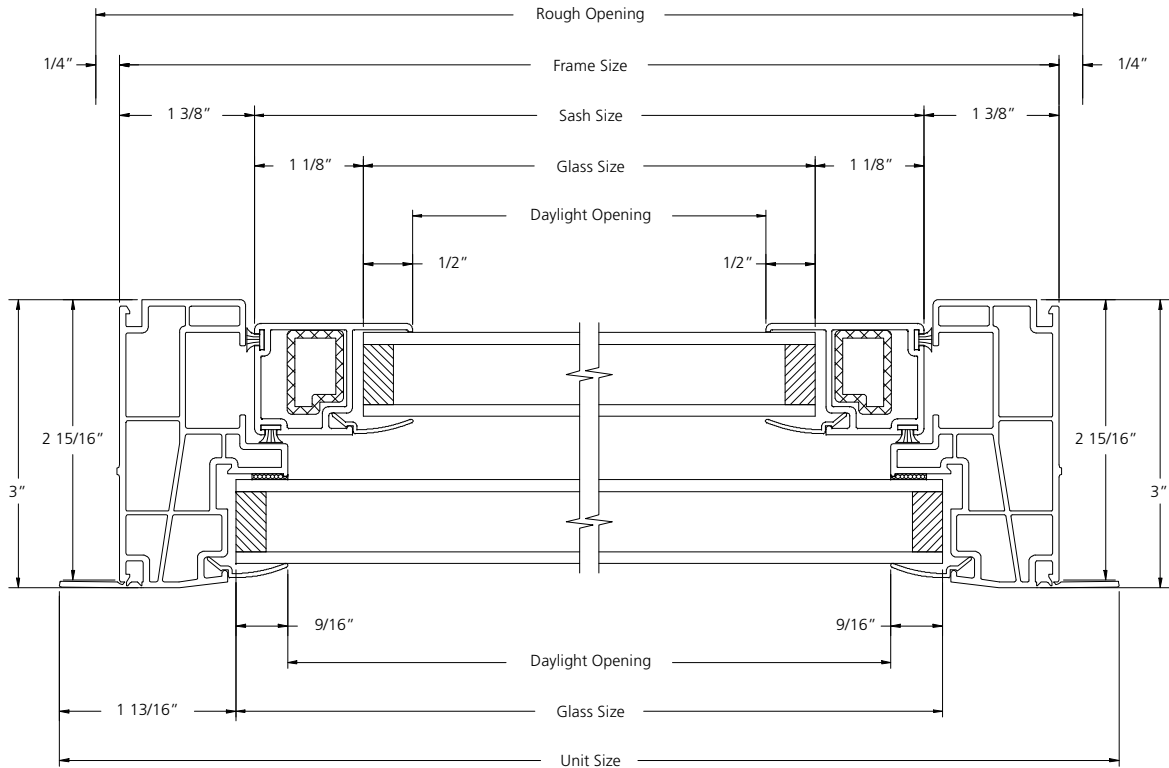

**HORIZONTAL SECTION**

SCALE: 6" = 1'



**SINGLE-HUNG UNIT  
POCKET**

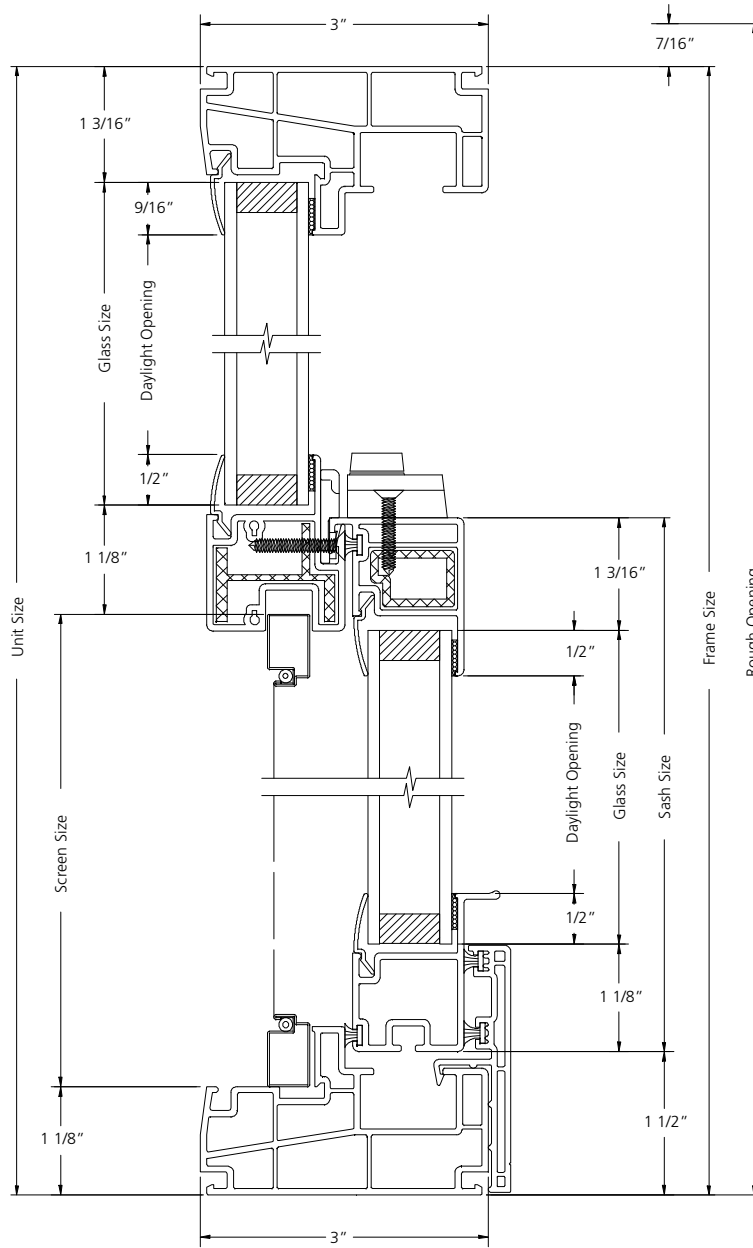

**VERTICAL SECTION**

SCALE: 6" = 1'

**SINGLE-HUNG UNIT  
POCKET**

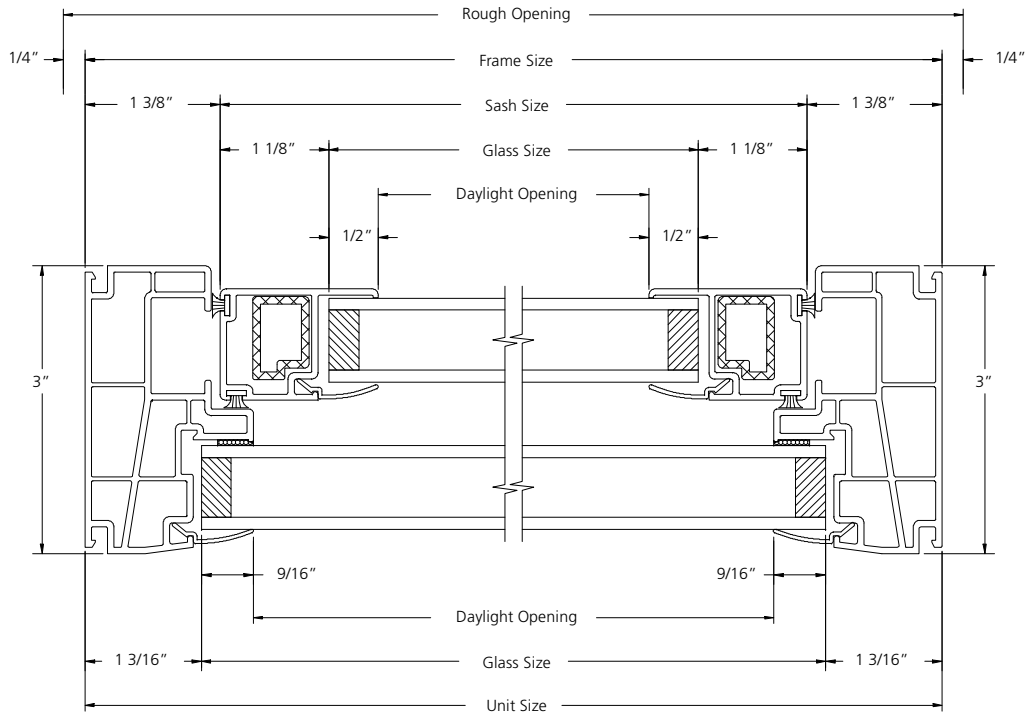

**HORIZONTAL SECTION**

SCALE: 6" = 1'